

Insert Bearing

UC300 Series-UC317-52

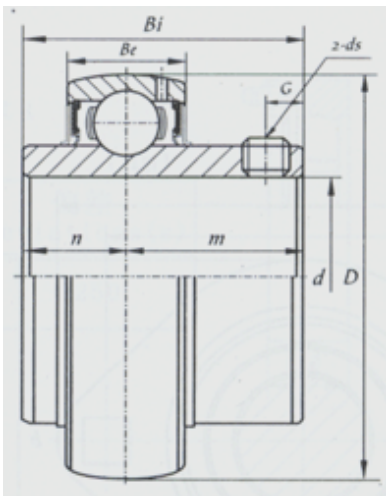

Bearing No.	UC317-52
d	
(mm)	82.55
(in.)	3.25
Dimensions [mm]	
D	180
Bi	96
Be	46
n	40
m	56
G	16
ds	5/8-18UNF

HEBEI HUANSHENG BEARING CO., LTD-Tel:+86-0319-8541203-Email:hbhs@hbhsbearing.com-
www.hbhsbearing.com